

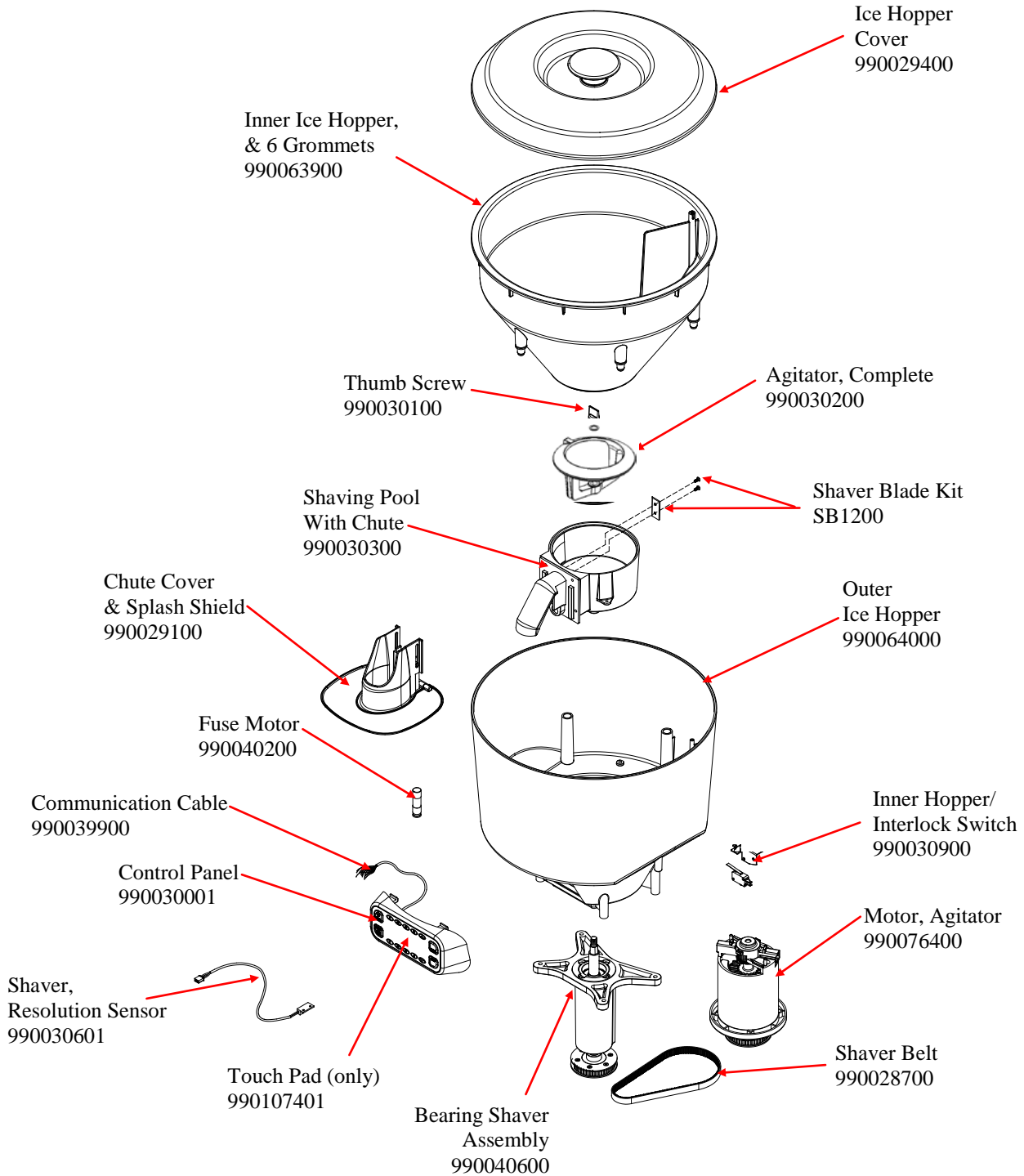

Replacement Parts Diagram Model HBS1200-CE

PROPRIETARY RIGHTS NOTICE This document and all information contained within it is the property of Hamilton Beach Brands, Inc. (HBB). It is confidential and proprietary and has been provided to you for a limited purpose. It must be returned or destroyed upon request. Disclosure, reproduction or use of this document and any information contained within it, in full or in part, for any purpose is forbidden without the prior written consent of HBB. No photographs may be taken of any article fabricated or assembled from this document without the prior written consent of HBB.



 Hamilton Beach 4421 Waterfront Drive Glen Allen, VA 23060	Revision Description:	Update Circuit Breaker Switch					
	Request Number:	DOC7298	Revision Date:	1/27/2017	Approved by:	DOC7298	
	Issue Code(s):		Page:	1 of 4	Document #:	540009000	Rev:

Replacement Parts Diagram Model HBS1200-CE

PROPRIETARY RIGHTS NOTICE This document and all information contained within it is the property of Hamilton Beach Brands, Inc. (HBB). It is confidential and proprietary and has been provided to you for a limited purpose. It must be returned or destroyed upon request. Disclosure, reproduction or use of this document and any information contained within it, in full or in part, for any purpose is forbidden without the prior written consent of HBB. No photographs may be taken of any article fabricated or assembled from this document without the prior written consent of HBB.

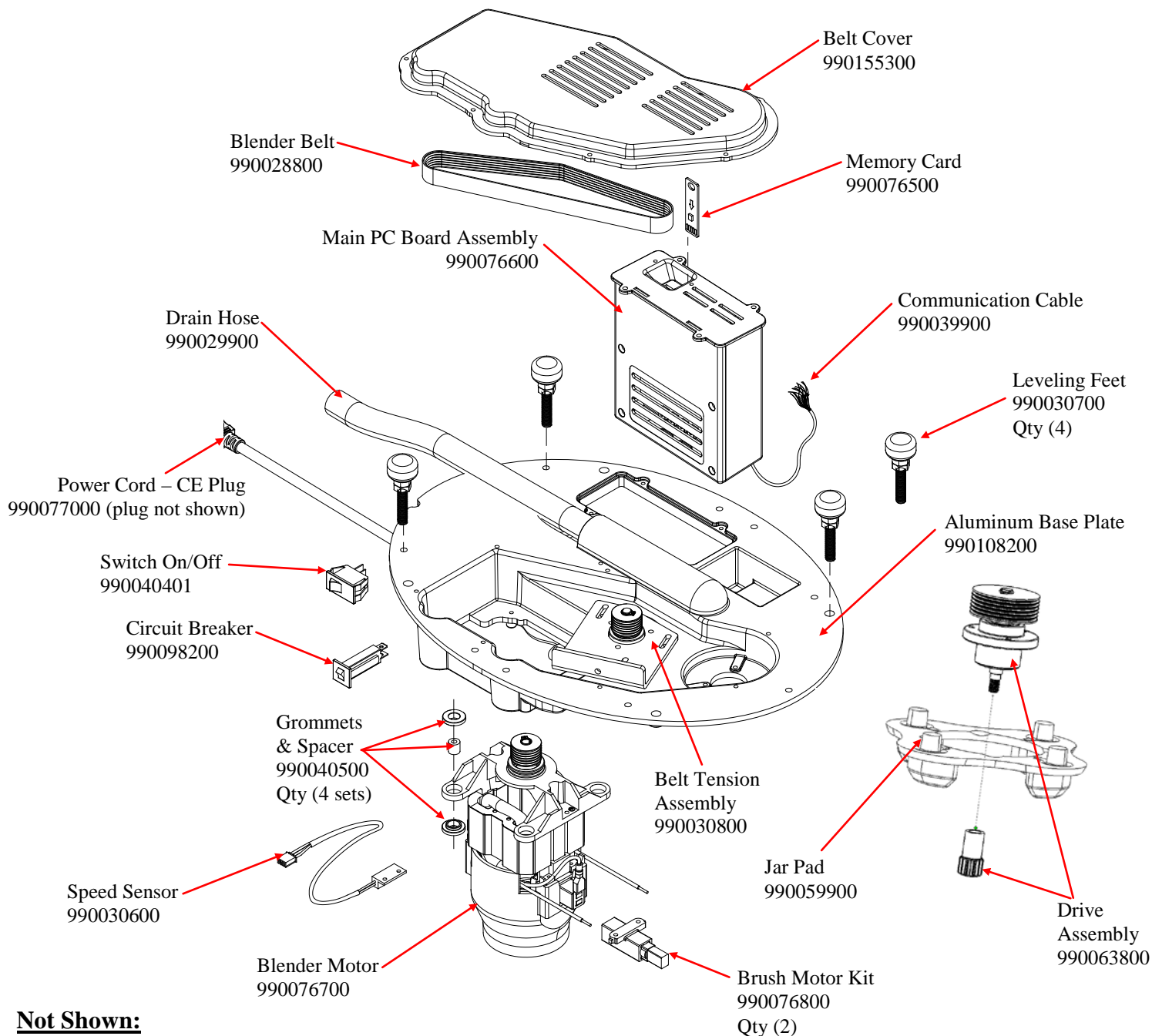

Not Shown:

- Jar Sensor – 990102400
- Drain Elbow Tube – 990104900
- Drain Hose Extension – 990105300
- Drain Tube with Sensor – 990109300
- Blender Base Plate – 990110900
- Memory Card Cover - 990084500

 <p>Hamilton Beach 4421 Waterfront Drive Glen Allen, VA 23060</p>	Revision Description:	Update Circuit Breaker Switch					
	Request Number:	DOC7298	Revision Date:	1/27/2017	Approved by:	DOC7298	
	Issue Code(s):		Page:	2 of 4	Document #:	540009000	Rev:

Replacement Parts Diagram

Model HBS1200-CE

PROPRIETARY RIGHTS NOTICE This document and all information contained within it is the property of Hamilton Beach Brands, Inc. (HBB). It is confidential and proprietary and has been provided to you for a limited purpose. It must be returned or destroyed upon request. Disclosure, reproduction or use of this document and any information contained within it, in full or in part, for any purpose is forbidden without the prior written consent of HBB. No photographs may be taken of any article fabricated or assembled from this document without the prior written consent of HBB.

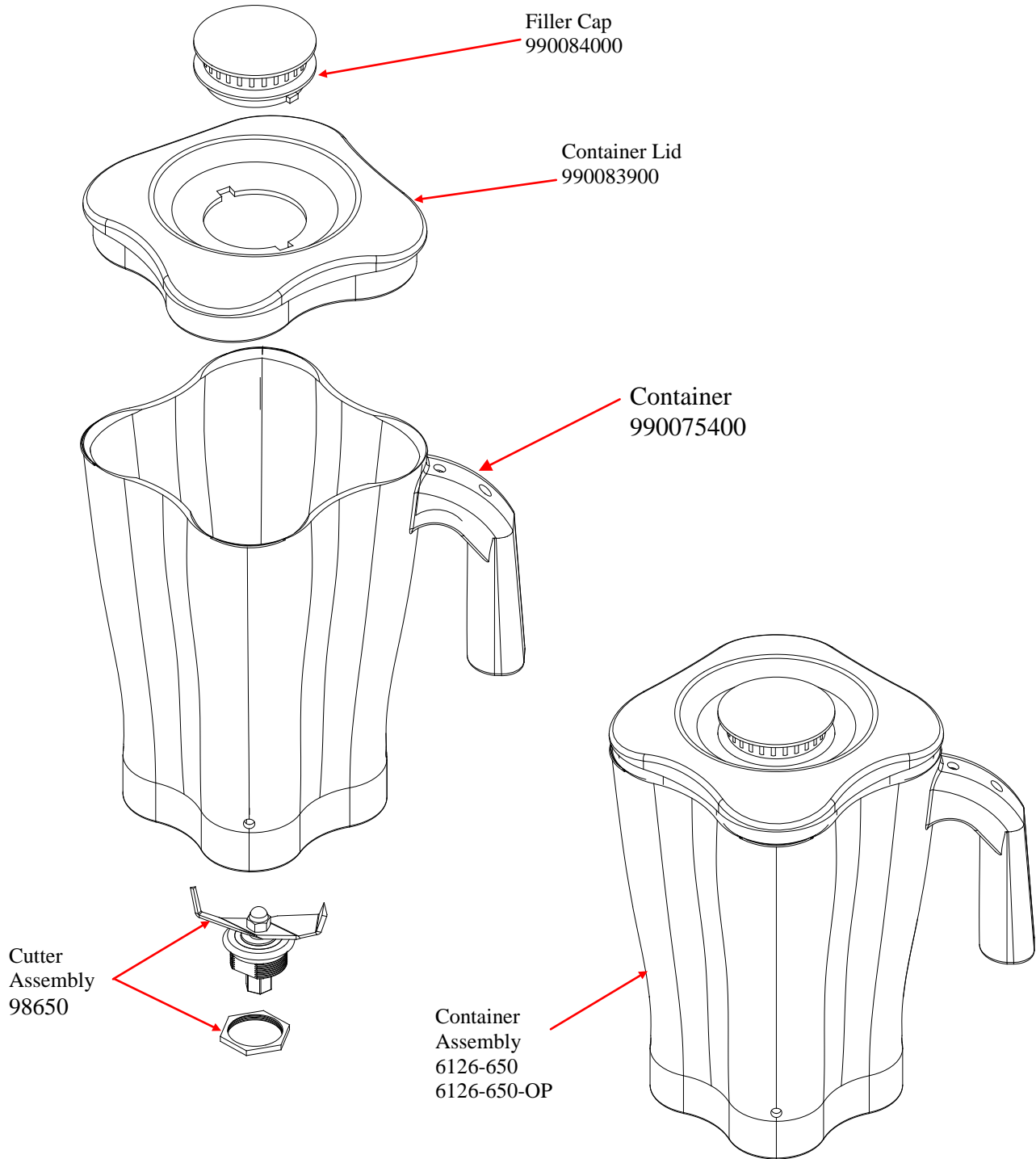

 <p>Hamilton Beach 4421 Waterfront Drive Glen Allen, VA 23060</p>	Revision Description: Update Circuit Breaker Switch		Revision Date: 1/27/2017		Approved by: DOC7298	
	Request Number: DOC7298	Page: 3 of 4		Document #: 540009000	Rev: D	
	Issue Code(s):					

Replacement Parts Diagram

Model HBS1200-CE

PROPRIETARY RIGHTS NOTICE This document and all information contained within it is the property of Hamilton Beach Brands, Inc. (HBB). It is confidential and proprietary and has been provided to you for a limited purpose. It must be returned or destroyed upon request. Disclosure, reproduction or use of this document and any information contained within it, in full or in part, for any purpose is forbidden without the prior written consent of HBB. No photographs may be taken of any article fabricated or assembled from this document without the prior written consent of HBB.

ACCESSORIES

Container Washer
BCR100

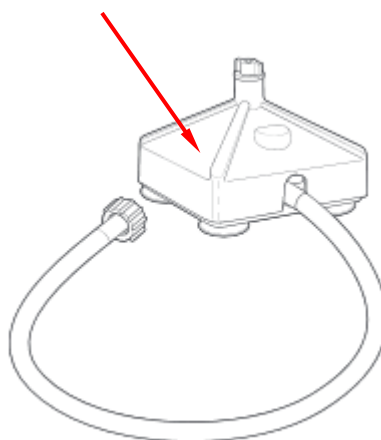

 4421 Waterfront Drive Glen Allen, VA 23060	Revision Description:		Update Circuit Breaker Switch					
	Request Number:	DOC7298	Revision Date:	1/27/2017	Approved by:	DOC7298		
	Issue Code(s):		Page:	4 of 4	Document #:	540009000	Rev:	D